

Multi-Objective Solution Based on Various Particle Swarm Optimization Techniques in Power Systems

Assad Abu-Jasser and Husam Shaheen

Electrical Engineering Department, The Islamic University of Gaza,
Gaza Engineering and Maintenance Administration, Ministry of Health, Gaza

Abstract: A proposed optimization technique based on fuzzy logic and particle swarm is presented in this paper. This technique is referred to as Fuzzy Adaptive Particle Swarm Optimization (FAPSO). In this technique, the fuzzy logic is employed to adjust the parameters of the particle swarm. The proposed technique is applied to the IEEE-30-bus-system model along with previous optimization methods to obtain a multi-objective solution to the voltage control, the voltage deviation, and the real power loss problems in power systems. The multi-objective problem is subjected to the same constraints for all methods and a comparison between the results obtained by various methods is presented. It has been demonstrated that the results of the proposed technique superseded that of all previous optimization technique methods.

Key words: Fuzzy logic, particle swarm optimization, voltage control, voltage deviation, voltage collapse

INTRODUCTION

It is of great importance to maintain acceptable voltage levels at all power system buses, since all present day equipments which utilize electric power such as lights; motors, thermal appliances, and electronic appliances are designed for use within a definite terminal voltage, the nameplate voltage. If the voltage deviates from this value, the efficiency, life expectancy, and the quality of performance of the equipment will suffer. Some electrical equipment is more sensitive to voltage variations than others such as motors. Despite the fact that several voltage-control techniques are available to electric power system operational staff, power systems are still subjected to voltage instabilities and in some cases to voltage collapses that could lead to sudden system breakdowns. Keeping the voltage profile at power system buses within a prescribed tolerance is a challenging task; however, it is not economically possible to maintain voltage absolutely constant at every consumer's service terminals (John and Joseph, 1954). This means that the variations in voltage are permissible, but within favorable zones, for example the rise or the drop in voltage should not exceed $\pm 5\%$ of the nominal voltage. Although a large spectrum of optimization problems has grown in size and complexity (Rardin, 1998), the solution to complex multidimensional problems by means of classical

optimization techniques is extremely difficult and computational expensive (Gray *et al.*, 1997). These tools include: Genetic algorithms, evolutionary strategies, evolutionary programming, simulated annealing, and particle swarm optimization (Van den Bergh, 2002; Al-Rashidi and El-Hawary, 2009).

Particle Swarm Optimization (PSO) (Venter and Sobieszczanski-Sobieski, 2002) refers to a relatively new family of algorithms that based on iterative process and may be used to find optimal or near optimal solutions to numerical and qualitative problems. Optimization was introduced by Russell and James (1995), and inspired by social behavior of bird flocking or fish schooling. Yoshida *et al.* (2000) proposed a Particle Swarm Optimization for reactive power and Voltage-VAR Control (VVC). It determines an on-line VVC strategy with continuous and discrete control variables such as automatic voltage regulator AVR, tap positions of online tap changing transformers and a number of reactive power compensation equipment. The PSO algorithm has three parameters called inertia weight (w), cognitive parameter (c_1), and social parameter (c_2). In adaptive particle swarm, the inertia weight (w) is modified according to linearly decreased equation while cognitive and social parameters remain constant during the iterative process according to (Cui-Ru *et al.*, 2005).

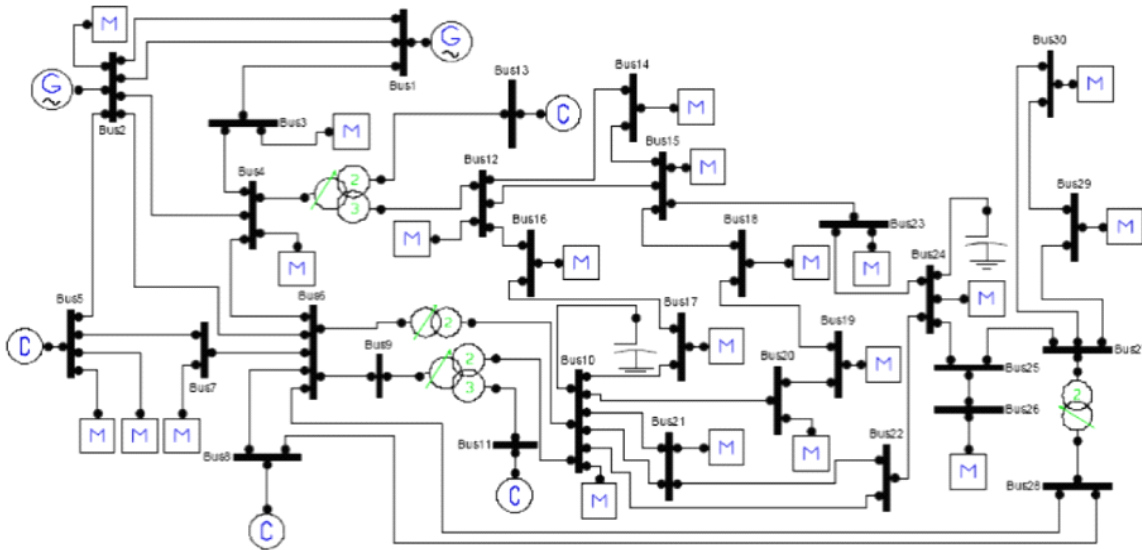

Fig. 1: The IEEE 30-Bus system model

Wen and Yutian (2008) presented Fuzzy Particle Swarm Optimization (FPSO). In the FPSO, the fuzzy system was used to modify all of the parameters of particle swarm optimization. The Fuzzy Adaptive Particle Swarm Optimization (FAPSO) was introduced as a new technique, where the inertia weight (w) of the APFO is adjusted separately according to a certain linear function while cognitive and social parameters are modified using the fuzzy logic.

The objective of this study is to demonstrate the superiority of the fuzzy adaptive particle swarm optimization technique over the other particle swarm methods. This will be done by obtaining a solution to the voltage control problem and at the same time keeping the voltage deviation and the real power loss as low as possible by employing various PSO techniques. At the end, a comparison between the outcomes of these techniques will be presented, taking the results of the classical Optimal Economic Dispatch (OED) as a reference case. In all cases, the voltage control problem will be treated through rescheduling of the reactive power generation (Prabha, 1994) and flow in the power system transmission lines taking advantage of the various control tools for the given loading condition (Thierry and Costas, 2008).

METHODOLOGY

In order to achieve the objectives and to make a comparison between the various PSO techniques to

demonstrate the superiority of the proposed FAPSO technique over other techniques, it is suggested to select an appropriate power system model, to develop an appropriate mathematical model for each technique, and finally to solve the mathematical model to obtain an acceptable voltage profile while keeping the voltage deviation and the real power loss as low as possible and at the same time to satisfy a number of constraints. It is also worth mentioning that this research has been conducted at the Electrical Engineering Department at the Islamic University of Gaza in the period between September 2009 and February 2010. The following summarizes these procedures and steps (Husam Shaheen, 2010):

- Selecting a system model that has an appropriate number of buses, number of transmission lines that includes a variety of voltage-control tools such as tap-changing transformers and capacitor banks.
- Formulating the voltage-control, the voltage deviation and the real power loss as mathematical optimization problems using the suggested control techniques subject to the applicable constraints.
- Solving the corresponding mathematical model applying the OED, PSO, APFO, FPSO and FAPSO techniques using Matlab code.
- Tabulating, examining, analyzing, and comparing the results obtained taking the results of OED method as a reference case.

System model description: The IEEE 30-bus system is proposed as a model system in order to examine and employ the stochastic optimization techniques. The system consists of thirty buses, bus number one is assigned as slack bus, while buses 2, 5, 8, 11, and 13 are taken as voltage controlled buses, and the remaining are load buses.

Four tap changer transformers are also available: the first transformer between bus number 6 and bus number 9, the second between bus number 6 and bus number 10, the third between bus number 4 and bus number 12, and the last transformer between bus number 28 and bus number 27. All tap settings of the four transformers are used as control variable. There are also two capacitor banks connected to buses 10 and 24 (Hadi, 2002). Figure 1 shows the system topology. The objective function of voltage-control problem comprises three important terms, which are: maintaining acceptable system voltage profile, minimizing the voltage deviation at the load buses, and minimizing the real power loss in the transmission grid. One of the effective ways to avoid the voltages from moving toward their maximum or minimum limits after optimization is to choose the deviation of voltage from the desired value as an objective function, that is:

$$\min f_1 = \sum_{i=1}^{N_L} \frac{|v_i - v_i^*|}{N_L} \quad (1)$$

where f_1 is the per unit average voltage deviation, N_L is the total number of the system load buses, v_i and v_i^* are the actual voltage magnitude and the desired voltage magnitude at bus i . Minimizing the total real power loss can be expressed as follows:

$$\min f_2 = P_{loss}(x, u) \quad (2)$$

where f_2 is the total active power losses of the power system, x is the state variable vector consisting of load bus voltages V_L , and generator reactive power outputs Q_G . While, u is the control variable vector consisting of generator voltages V_G , shunt VAR compensation Q_c , and transformer tap settings T . On the other hand, the mathematical formulation can be expressed as follows:

$$\min f_2 = \min \left\{ \sum_{i=1}^N \sum_{j=1}^N \left[g_{ij} \times (|v_i|^2 + |v_j|^2 - 2 \times |v_i| \times |v_j| \times \cos(\delta_i - \delta_j)) \right] \right\} \quad (3)$$

where;

- N : Number of buses
- $|V_i|$: Voltage magnitude at bus i
- $|V_j|$: Voltage magnitude at bus j
- g_{ij} : Conductance of transmission line between bus i and bus j
- δ_i : Voltage angle at bus i
- δ_j : Voltage angle at bus j

The following constraints are known as the power balance constraints. They guarantee that the load demand will be met considering the transmission losses of the system. These constraints are the main objective in a power flow analysis.

$$\sum P_G - \sum P_D - P_L = 0 \quad (4)$$

$$\sum Q_G - \sum Q_D - Q_L = 0 \quad (5)$$

where;

- P_G : Real power generation
- P_D : Real power demand
- P_L : Real power loss
- Q_G : Reactive power generation
- Q_D : Reactive power demand
- Q_L : Reactive power loss

The operational constraints guarantee a safe operation of the system. The capacity limits should be met at all time to avoid damage to power system components and maintain system stability. The following constraints state real and reactive power generation limits for each generation unit:

$$P_{Gi}^{\min} \leq P_{Gi} \leq P_{Gi}^{\max} \quad (6)$$

$$Q_{Gi}^{\min} \leq Q_{Gi} \leq Q_{Gi}^{\max} \quad (7)$$

where;

- P_{Gi}^{\min} : Lower real power generation limit of unit i
- P_{Gi}^{\max} : Upper real power generation limit of unit i
- Q_{Gi}^{\min} : Lower reactive power generation limit of unit i
- Q_{Gi}^{\max} : Upper reactive power generation limit of unit i

In order to maintain system stability, the voltage at each bus should be within its limits. The following constrain shows this operational condition:

Table 1: The control variable solution by OED

Control variables vector or particle											
V_1	V_2	V_5	V_8	V_{11}	V_{13}	T_{6-9}	T_{6-10}	T_{4-12}	T_{28-27}	Q_{10}	Q_{24}
1.05	1.05	1.05	1.05	1.05	1.05	0.9780	0.9690	0.9320	0.9680	10	4.3

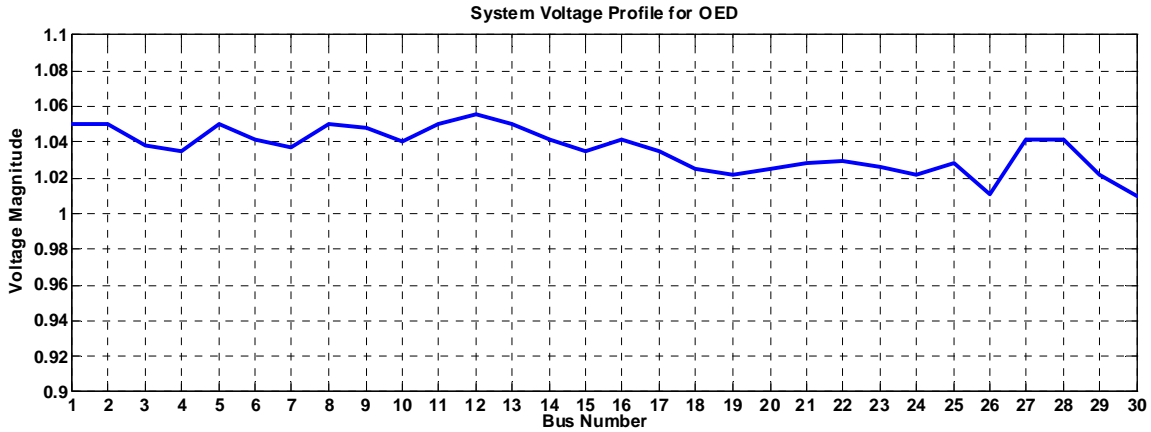

Fig. 2: System voltage profile for OED

$$v_i^{\min} \leq |v_i| \leq v_i^{\max} \quad (8)$$

T_k^{\min} : Lower tap position limit of transformer k

T_k^{\max} : Upper tap position limit of transformer k

where;

v_i^{\min} : Lower voltage magnitude limit at bus i

v_i^{\max} : Upper voltage magnitude limit at bus i

The optimal voltage-control and reactive power dispatch can be achieved by employing reactive power compensator devices such as shunt capacitor banks, and by adjusting the transformer tap positions, and these devices are used as control variables for the voltage-control problem. The operational limits of these devices are expressed in the following constrains:

$$Q_c^{\min} \leq Q_c \leq Q_c^{\max} \quad (9)$$

$$T_k^{\min} \leq T_k \leq T_k^{\max} \quad (10)$$

where;

Q_c : Reactive power generated by the shunt capacitor bank C

Q_c^{\min} : Lower limit of shunt capacitor bank C

Q_c^{\max} : Upper limit of shunt capacitor bank C

T_k : Tap position of transformer k

The transformer tap settings and the adjustable shunt capacitor banks are the essential key elements in transmission loss reduction. In power systems, almost all transformers provide taps on windings to adjust the ratio of transformation, also have adjustable shunt capacitor banks located in specified buses in order to correct voltage and power factor problems. In a mathematical formulation, the transformers tap settings and the adjustable shunt capacitor banks may be represented either as continuous or discrete variables, depending on the study issued. In this work, the transformers tap settings and the adjustable shunt capacitor banks are considered as continuous variables. Variables values were forced to be within their limits. Any parameter that violates the limits is replaced with values using Eq. (11):

$$u_i = \begin{cases} u_i^{\min} & \text{if } u_i < u_i^{\min} \\ u_i^{\max} & \text{if } u_i > u_i^{\max} \\ u_i & \text{otherwise} \end{cases} \quad (11)$$

where;

u_i is any parameter variable

Optimal economic dispatch results: The Newton-Raphson Optimal Power Flow method is employed as a reference case for solving the voltage-control problem. The simulation results show that the voltage magnitudes obtained are within the range (0.95-1.05). Also the real power generation, reactive power generation, and all control variables are within the ranges specified. The results of the simulation can be summarized as follows: The total system loss, TSL = 8.3703-j13.6527 MVA, the voltage deviation, VD = 0.0325 pu, the incremental fuel cost, $\lambda = 3.3897$ \$/MWH, the total cost, TC = 782.2480 \$/H, and the time elapsed for this simulation, t = 0.2383 S. The system voltage profile is shown in Fig. 2 while Table 1 contains the magnitude of all control variables.

Particle Swarm Optimization (PSO): The control variables for voltage-control problem which will be modified by the particle swarm optimization process are: the voltage magnitude at the slack bus, the voltage level at the voltage-controlled buses, transformers' tap settings, and adjustable shunt capacitor banks. There are twelve control variables for the IEEE 30-Bus system. The first position of control variables vector is the slack bus. The next five position for the five voltage magnitudes at the voltage-controlled buses (PV-buses). The next four positions of the control variables vector are the transformers' tap settings. The transformer tap settings are considered as continuous variables, they are adjusted in the range [0.9-1.1]. The last two positions of the control variables vector are the adjustable shunt capacitor banks. These variables are also considered as continuous variables, they are adjusted in the range [0-10 MVAR]. All control variables were handled using the Particle Swarm Optimization model for continuous variables. At each iteration: every particle determines a possible set of values for voltage magnitudes at PV buses, transformers' tap positions and total reactive power of each shunt capacitor bank. Subsequently, they are used to run a power flow, calculate the transmission losses, voltage deviation and evaluate the fitness function. The particle swarm optimization contains three tuning parameters w , c_1 and c_2 as shown in Eq. (12) and (13) that influences the algorithm performance, often stated as the exploration-exploitation tradeoff. Exploration is the ability to test various regions in the problem space in order to locate a good optimum, the global one. Exploitation is the ability to concentrate the search around a promising candidate solution in order to locate the optimum precisely. The inertia weight w is employed to control the impact of the previous history of velocities on the current velocity.

$$v_i^{k+1} = w \times v_i^k + c_1 \times rand()_1 \times (pbest_i - s_i^k) + c_2 \times rand()_2 \times (gbest - s_i^k) \quad (12)$$

$$S_i^{k+1} = S_i^k + v_i^{k+1} \quad (13)$$

where,

- v_i^{k+1} : velocity of particle i at iteration k + 1
- v_i^k : velocity of particle i at iteration k
- S_i^{k+1} : position of particle i at iteration k + 1
- S_i^k : position of particle i at iteration k
- w : inertia weight
- c_1 : constant weighting factor related to pbest
- c_2 : constant weighting factor related to gbest
- $rand()_1$: random number between 0 and 1
- $rand()_2$: random number between 0 and 1
- $pbest_i$: pbest position of particle i
- $gbest$: gbest position of swarm

Expressions in equations (12) and (13), describe the velocity and position update, respectively (Wen and Yutian, 2008). The expression in equation (12) calculates a new velocity for each particle based on the particle's previous velocity, the particle's location at which the best fitness has been achieved so far, and the population global location at which the best fitness has been achieved so far. In addition, c_1 and c_2 are positive constants called the cognitive and the social parameters, respectively. These constants provide the correct balance between exploration and exploitation (individuality and sociality). Acceleration is weighted by a random term, with separate random numbers being generated for acceleration toward p-best and g-best locations. The random numbers provide a stochastic characteristic for the particles velocities in order to simulate the real behavior of the birds in a flock. An inertia weight parameter w was introduced in order to improve the performance of the original Particle Swarm Optimization model. This parameter plays the role of balancing the global search and local search capability of Particle Swarm Optimization. It can be a positive constant or even a positive linear or nonlinear function of time. A larger inertia weight w facilitates global exploration while a smaller inertia weight tends to facilitate local exploration to fine-tune the current search area. Suitable selection of the inertia weight w can provide a balance between global and local exploration abilities, thus require less iterations on average to find the optimum. The

Table 2: The control variable solution by Particle Swarm Optimization
Control variables vector or particle

V_1	V_2	V_5	V_8	V_{11}	V_{13}	T_{6-9}	T_{6-10}	T_{4-12}	T_{28-27}	Q_{10}	Q_{24}
1.05	1.042	1.013	1.025	0.969	1.050	1.0467	0.9000	1.0577	0.9758	7.73	0.00

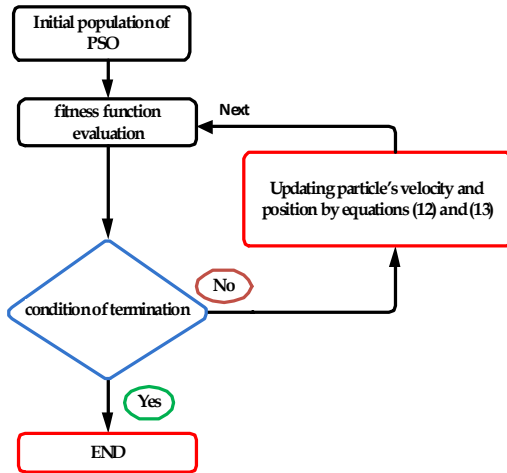

Fig. 3: Flow chart of the particle swarm optimization

learning factors c_1 and c_2 determine the influence of personal best p-best and global best g-best. Since c_1 expresses how much the particle trusts its own past experience, it is called cognitive parameter. While c_2 expresses how much it trusts the swarm, it is called social parameter. In addition the PSO is influenced by the number of particles and the swarm size N , in the swarm. Since the parameters of PSO are influenced and deeply affect the algorithm performance, we concentrate in this paper on these parameters. Each control variables vector or particle was evaluated according to the following steps:

- Step 1:** Initial search points and velocities are randomly generated for each of the three variables between their upper and lower bounds.
- Step 2:** Power loss and voltage deviation for each set (one value of voltage-controlled bus, transformer tap position and adjustable shunt capacitor) of particles is evaluated based on the fitness function. If the constraints are violated, the control variable is corrected according to Eq. (11).
- Step 3:** Assign the particle's position to p-best position and fitness to p-best fitness. Identify the best among the p-bests as the g-best.

- Step 4:** New velocities and new search points (directions) are formulated using the Eq. (12) and (13), respectively.
- Step 5:** Power loss and voltage deviation corresponding to the new search points and velocities are evaluated.
- Step 6:** Compare the best current fitness evaluation with the population's g-best. If the current value is better than the g-best, reset g-best to the current best position and fitness value.
- Step 7:** If iteration reaches maximum number, then exit, otherwise go to step 4.

The model of PSO can be as shown in Fig. 3.

The particle swarm optimization was employed with inertia weight $w = 0.9$, the cognitive and the social parameters $c_1 = c_2 = 1$, swarm size 50 and the number of iteration 20. After the run is complete, the voltage magnitudes obtained are within the range (0.95-1.05). The real and reactive power generations are also within the range. It is noted that the reactive power needed at bus number 10 equals 7.73 MVAR, while no reactive power is needed from the bank at bus number 24. In Particle swarm optimization method, all control variables are within the range specified and the output of simulation can be summarized as follows: the total system loss, TSL = 8.0359-j9.1446 MVA, the voltage deviation, VD = 0.0206 pu, the incremental fuel cost, $\lambda = 3.3869$ \$/MWH, the total cost, TC = 781.8074 \$/H, and the time elapsed for this simulation, $t = 13.3194$ S. The system voltage profile for this method is shown in Fig. 4 followed by Table 2 that shows the control variables obtained employing the particle swarm optimization technique.

Adaptive Particle Swarm Optimization algorithm (APSO): In the adaptive particle swarm optimization, the inertia weight decreased linearly according to the following equation:

$$w = w_{\max} - \left(\frac{w_{\max} - w_{\min}}{iter_{\max}} \right) \times iter \quad (14)$$

where;

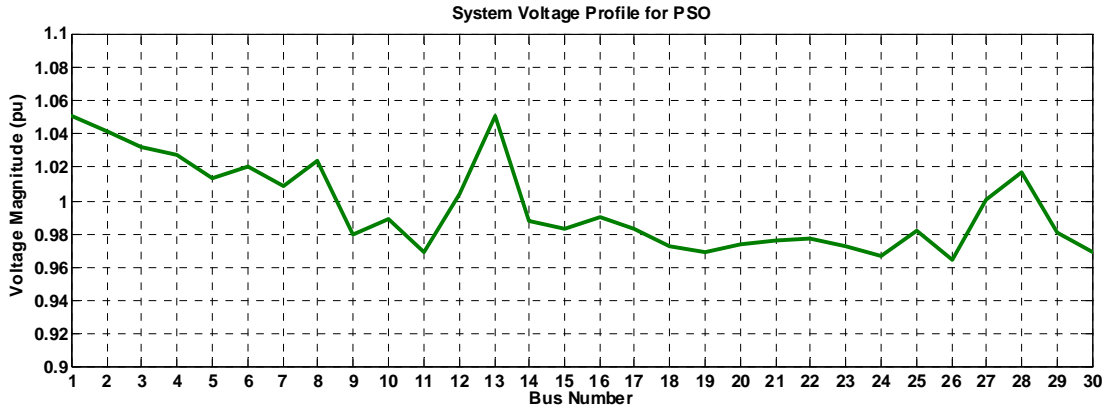

Fig. 4: System voltage profile for PSO

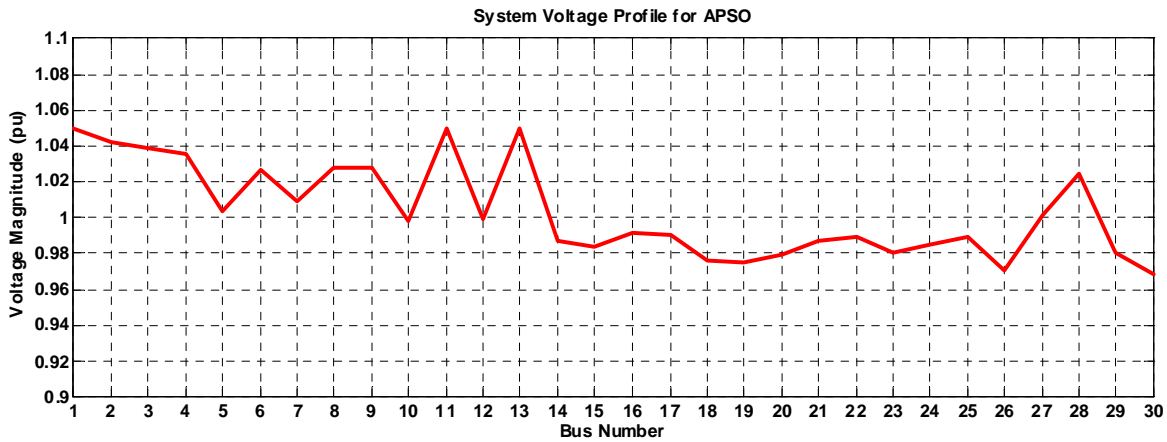

Fig. 5: System voltage profile for APSO

Table 3: The control variable solution by APSO

Control variables vector or particle

V_1	V_2	V_5	V_8	V_{11}	V_{13}	$T_{6,9}$	$T_{6,10}$	$T_{4,12}$	$T_{28,27}$	Q_{10}	Q_{24}
1.05	1.042	1.004	1.028	1.050	1.050	0.9646	1.0948	1.1000	0.9954	9.23	10

$iter_{max}$: maximum number of iteration

$iter$: current iteration number

w_{max} : maximum inertia weight

w_{min} : minimum inertia weight

while setting $c_1 = c_2 = 1.0$, which means that each particle will be attracted to the average of p-best and g-best. The swarm size is taken at 50 and the number of iterations is set at 20. Note that the voltage magnitudes on load buses are within the range, also the capacitor banks on bus number 10 is increased to 9.23 MVAR and has a maximum (10 MVAR) on bus number 24. In the adaptive

particle swarm optimization methods, all control variables are within the range specified and the output of simulation as follows: the total system loss, TSL = 7.9509-j10.1218 MVA, the voltage deviation, VD = 0.018 pu, the incremental fuel cost, $\lambda = 3.3846$ \$/MWH, the total cost, TC=781.677 \$/H, and the time elapsed for this simulation, $t = 12.5933$ S. The system voltage profile is shown in Fig. 5 and Table 3 shows the control variables obtained using the adaptive particle swarm optimization method.

Fuzzy Particle Swarm Optimization Algorithm (FPSO): A fuzzy particle swarm optimization (FPSO) is

intended to improve the performance of PSO; a fuzzy system will be employed to adjust the parameters of PSO, the inertia weight w and learning factors c_1 and c_2 during the evolution process. From experience, it is known that:

- When the best fitness is low at the end of the run in the optimization of a minimum function, low inertia weight and high learning factors are often preferred.
- When the best fitness is stuck at one value for a long time, number of generations for unchanged best fitness is large. The system is often stuck at a local minimum, so the system should probably concentrate on exploiting rather than exploring. That is, the inertia weight should be increased and learning factors should be decreased. Based on this kind of knowledge, a fuzzy system is developed to adjust the inertia weight, and learning factors with best fitness (BF) and number of generations for unchanged best fitness (NU) as the input variables, and the inertia weight (w) and learning factors (c_1 and c_2) as output variables. The BF measures the performance of the best candidate solution found so far. Different optimization problems have different ranges of BF value. To design a FPSO applicable to a wide range of problems, the ranges of BF and NU are normalized into $[0, 1.0]$. To convert BF to a normalized BF format, we use Eq. (15):

$$NBF = \frac{(BF - BF_{min})}{(BF_{max} - BF_{min})} \quad (15)$$

where BF_{min} is the real minimum fitness value and BF_{max} is greater than the maximum fitness value. NU can be converted into $[0, 1.0]$ in similar way. The value for w is bounded between $0.2 \leq w \leq 1.2$ and the values of c_1 and c_2 are bounded between $1.0 \leq c_1, c_2 \leq 2.0$. In the fuzzy particle swarm optimization, each control variables vector or particle was evaluated according to the following steps:

- Step 1:** Input the power system data and the FPSO parameter limits.
- Step 2:** Generate the initial searching points and velocities of particles randomly and uniformly in the searching space. For each particle, calculate objective functions.
- Step 3:** Set each initial searching point to p-best; the initial best evaluated value among p-best is set to g-best.
- Step 4:** Update the FPSO control parameters (w , c_1 and c_2) by the fuzzy system.

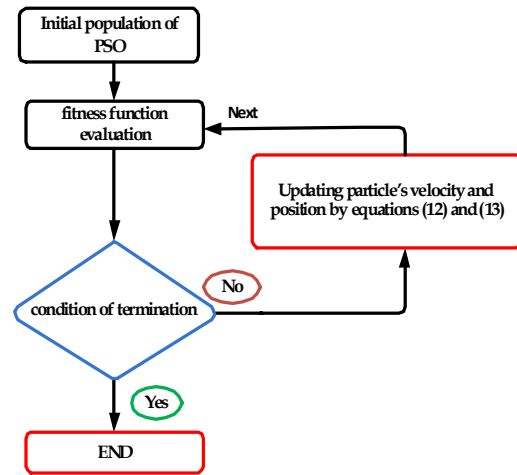

Fig. 6: Flow Chart of the fuzzy particle swarm optimization method

- Step 5:** New velocities and searching points are calculated using (12) and (13).
- Step 6:** Evaluate all the particles in the new position. That is to calculate objective functions.
- Step 7:** If the evaluation value of each particle is better than the previous p-best, the value is set to p-best; if the best p-best is better than g-best, the value is set to g-best. All of g-bests are stored as candidates for the final solution.
- Step 8:** If iteration reaches maximum number, then exit, otherwise go to step 4. The model of FPSO can be described as shown in Fig. 6.

The membership function of inputs and outputs of FPSO model is shown in Fig 7-11. The fuzzy system consists of four principal components (Li-Xin, 1997): fuzzification, fuzzy rules, fuzzy reasoning and defuzzification, which are described as following:

Fuzzification: Among a set of membership functions, left-triangle, triangle and right-triangle membership functions are used for every input and output as illustrated in Fig. 7-11. Four membership function were used in this work PS (positive small), PM (positive medium), PB (positive big) and PR (positive bigger) are the linguist variables for the inputs and outputs.

Fuzzy rules: The Mamdani-type fuzzy rule is used to formulate the conditional statements that comprise fuzzy logic. The fuzzy rules in Table 4 is used to adjust the

Table 4: Fuzzy rules for inertia weight (w), and learning factor c_1 and c_2

w	c ₁				c ₂									
	NU	PS	PM	PB	PR	NU	PS	PM	PB	PR				
NBF	PS	PM	PB	PR	NBF	PS	PM	PB	PR	NBF	PS	PM	PB	PR
PS	PS	PM	PB	PB	PS	PR	PB	PB	PM	PS	PR	PB	PM	PM
PM	PM	PM	PB	PR	PM	PB	PM	PM	PS	PM	PM	PB	PM	PS
PB	PB	PB	PB	PR	PB	PB	PM	PS	PS	PB	PM	PM	PS	PS
PR	PB	PB	PR	PR	PR	PM	PM	PS	PS	PR	PM	PS	PS	PS

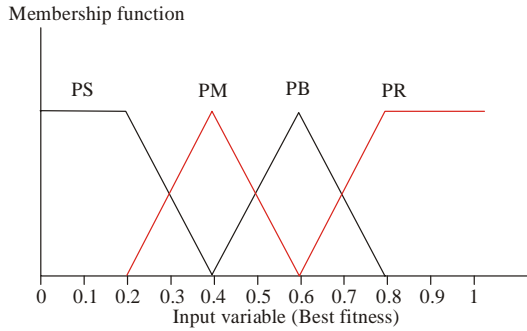

Fig. 7: Membership function of Best fitness BF

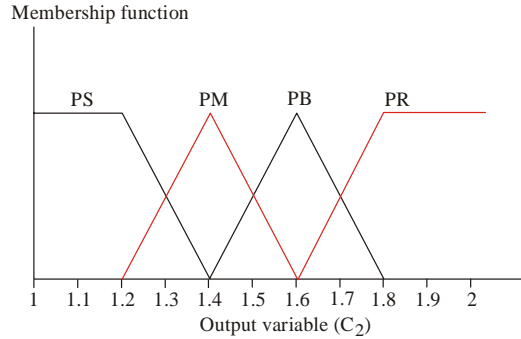

Fig. 10: Membership function for learning factor c_2

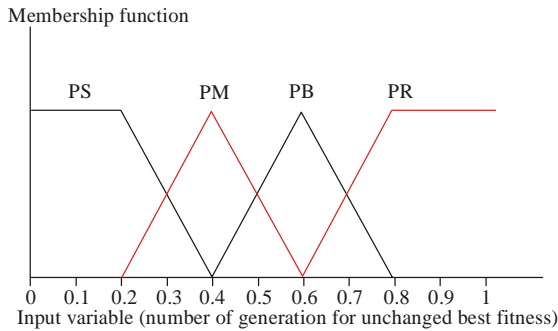

Fig. 8: Membership function of number of generations for unchanged best fitness NU

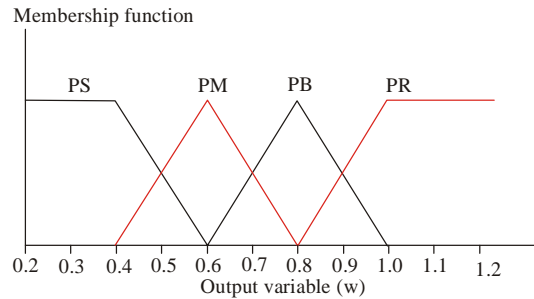

Fig. 11: Membership function of inertia weight w

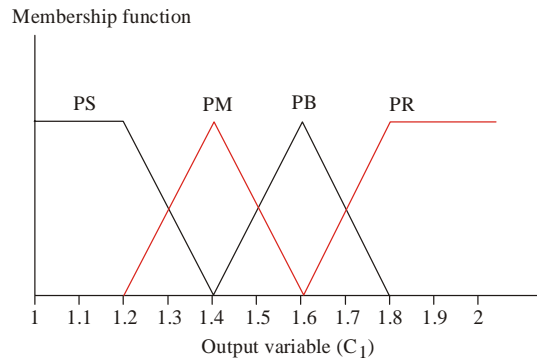

Fig. 9: Membership function for learning factor c_1

inertia weight (w) and learning factors (c_1 and c_2), respectively. Each rule represents a mapping from the input space to the output space.

Fuzzy reasoning: The fuzzy control strategy is used to map from the given inputs to the outputs (Timothy, 1997). Mamdani's fuzzy inference method is used in this study (Mamdani, 1974). The AND operator is typically used to combine the membership values for each fired rule to generate the membership values for the fuzzy sets of output variables in the consequent part of the rule. Since there may be several rules fired in the rule sets, for some fuzzy sets of the output variables there may be different membership values obtained from different fired rules. These output fuzzy sets are then aggregated into a single

Table 5: The control variable solution by Fuzzy Particle Swarm Optimization

Control Variables Vector or Particle											
V_1	V_2	V_5	V_8	V_{11}	V_{13}	$T_{6,9}$	$T_{6,10}$	$T_{4,12}$	$T_{28,27}$	Q_{10}	Q_{24}
1.05	1.0383	1.0135	1.0213	1.040	1.050	1.0592	0.900	0.9980	1.0167	9.84	10

Table 6: The control variable solution by FAPSO

Control Variables Vector or Particle											
V_1	V_2	V_5	V_8	V_{11}	V_{13}	$T_{6,9}$	$T_{6,10}$	$T_{4,12}$	$T_{28,27}$	Q_{10}	Q_{24}
1.05	1.039	1.011	1.023	1.05	1.043	1.0099	0.9234	1.0254	0.9796	0	9.43

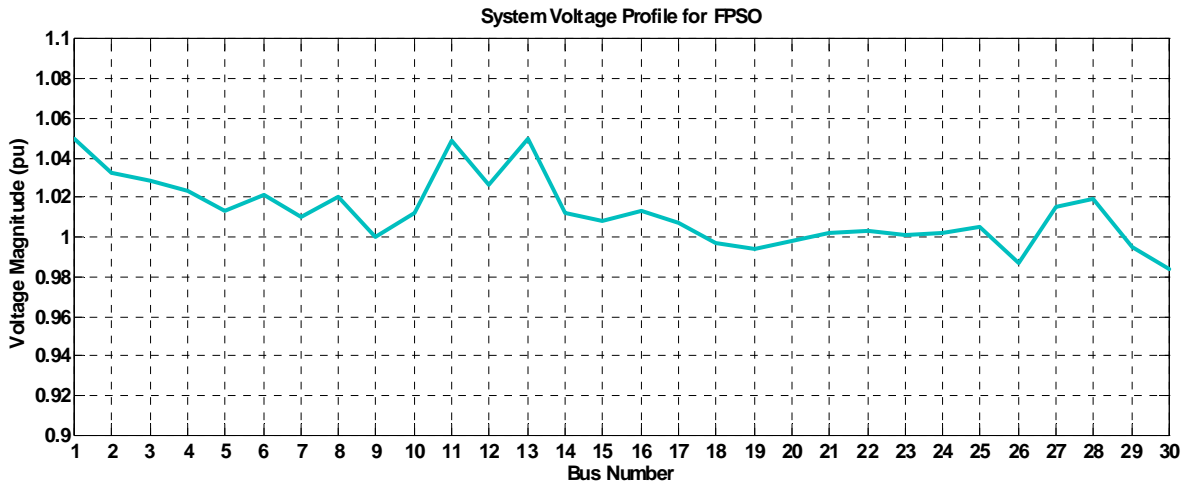

Fig. 12: System voltage profile for FPSO

output fuzzy set by OR operator. That is to take the maximum value as the membership value of that fuzzy set.

Defuzzification: To obtain a deterministic control action, a defuzzification strategy is required. The method of centroid (center-of-sums) is used as shown below:

$$y = \frac{\int_y \sum_{i=1}^n y \cdot \mu_{Bi}(y) dy}{\int_y \sum_{i=1}^n \mu_{Bi}(y) dy} \quad (16)$$

Defuzzified value is directly acceptable values of w , c_1 and c_2 parameters, where the input for the defuzzification process is a fuzzy set $\mu_{Bi}(y)$ (the aggregate output fuzzy set) and the output is a single number y .

Note that the voltage magnitudes are within the range (0.95- 1.05) with decreased in voltage deviation, also the real and reactive power generation are within the range. The capacitor banks are increased and within its range. In the fuzzy particle swarm optimization methods, all control variables are within the range specified and the output of

simulation as follows: The total power loss, TSL = 7.8699-j11.6112 MVA, the voltage deviation, VD = 0.0146 pu, the incremental fuel cost, $\lambda = 3.3836$ \$/MWH, the total cost, TC = 781.1845 \$/H, the time elapsed for this simulation, $t = 14.0566$ S. The system voltage profile is shown in Fig. 12.

Table 5 contains the values for the control variables obtained by employing the fuzzy particle swarm optimization.

Fuzzy adaptive particle swarm optimization algorithm:

This new control method combined both fuzzy system and adaptive particle swarm optimization, where the inertia weight was modified according to Eq. (14), while c_1 and c_2 are modified according to fuzzy logic presented in the previous section. The fuzzy rule base and membership functions used in FAPSO are the same as in the FPSO apart from the inertia weight. The voltage magnitudes are within the range (0.95-1.05) with decreased in voltage deviation to 0.0109. The real and reactive power generations are within the range, while the capacitor bank equal 9.43 on bus number 24 and equal 0 on bus number 10. Table 6 shows the control variable results obtained. In the fuzzy adapted particle swarm

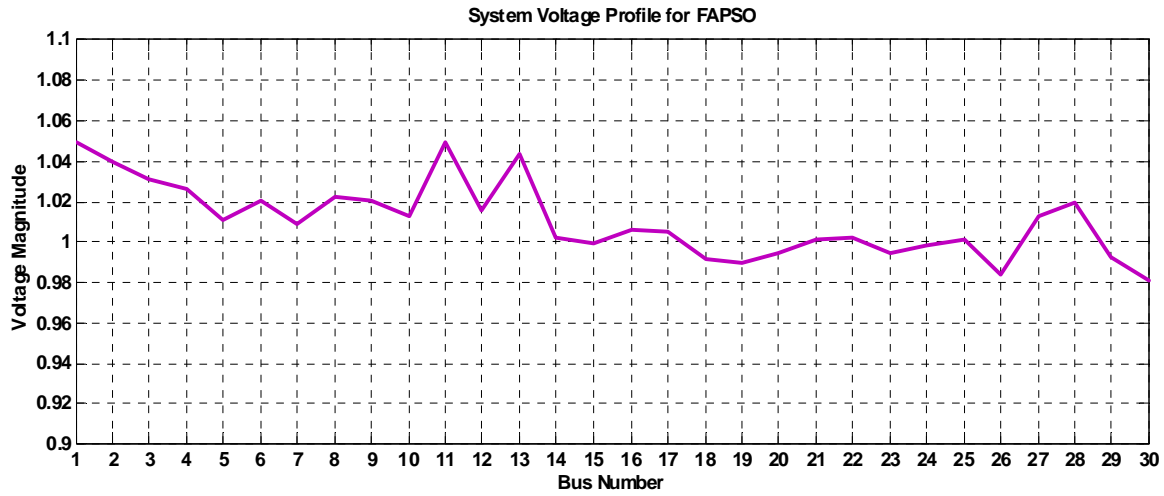

Fig. 13: System voltage profile for FAPSO

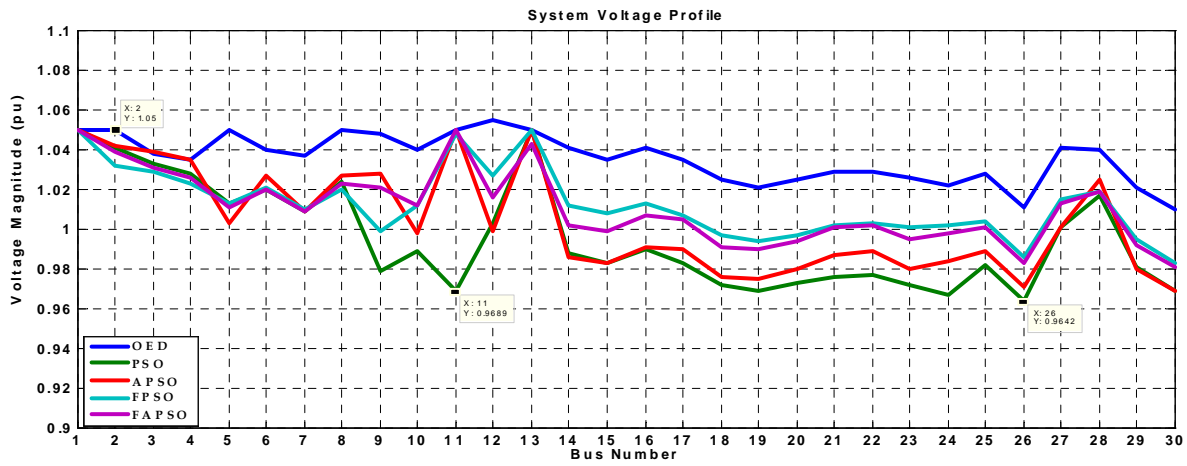

Fig. 14: System voltage profile

Table 7: The control variable limits and optimal control value

Control Variable	Control variable limits		OED	PSO	APSO	FPSO	FAPSO
	Min	Max					
V_{G1}	0.95	1.05	1.050	1.050	1.050	1.0500	1.050
V_{G2}	0.95	1.05	1.050	1.042	1.042	1.0383	1.039
V_{G5}	0.95	1.05	1.050	1.013	1.004	1.0135	1.011
V_{G8}	0.95	1.05	1.050	1.025	1.028	1.0213	1.023
V_{G11}	0.95	1.05	1.050	0.969	1.050	1.0403	1.050
V_{G13}	0.95	1.05	1.050	1.050	1.050	1.0500	1.043
T_{6-9}	0.90	1.10	0.978	1.047	0.965	1.0590	1.010
T_{6-10}	0.90	1.10	0.969	0.900	1.095	0.9000	0.923
T_{4-12}	0.90	1.10	0.932	1.058	1.100	0.9980	1.025
T_{28-27}	0.90	1.10	0.968	0.976	0.995	1.0170	0.980
Q_{c10}	0.00	0.10	0.010	0.0773	0.0923	0.0984	0.000
Q_{c24}	0.00	0.10	0.043	0.000	0.010	0.0100	0.0943

Table 8: Results from various voltage control methodology

Control strategy	VD (pu)	(MW)	λ (\$/MWH)	TC (\$/H)	t (s)	Reduction VD (%)	Reduction R (%)
OED	0.0325	8.3703	3.3897	782.2480	0.2383	Original	Original
PSO	0.021	8.0359	3.3869	781.8074	13.3194	35.38	3.99
APSO	0.018	07.9509	3.3846	781.677	12.5933	44.61	5.01
FPSO	0.0146	7.8699	3.383691	781.1845	14.0566	55.07	5.97
FAPSO	0.0109	7.8369	3.382931	780.9932	14.1275	66.46	6.37

optimization method, all control variables are within the range specified and the output of simulation as follows: The total system loss, TSL = 7.8369-j13.1478 MVA, the voltage deviation, VD = 0.0109 pu, the incremental fuel cost, λ = 3.3829 \$/MWH, the total cost, TC = 780.9932 \$/H, and the time elapsed for this simulation is t = 14.1275 sec. The system voltage profile is shown in Fig. 13 and Table 6 shows the magnitude of the corresponding control variables obtained by using the fuzzy adaptive particle swarm optimization technique.

The system voltage profile: The system voltage profile obtained by optimal economic dispatch, particle swarm optimization, adaptive particle swarm optimization, fuzzy particle swarm optimization and fuzzy adaptive particle swarm optimization meet the main objective criterion and these values are depicted in Fig. 14.

The control variable limits and optimal control of IEEE-30 bus power system can be summarized in Table 7. It is noted that all control variables met their operational limits for all cases. It is noted that the voltage magnitudes of all PV buses, transformers tap settings and shunt capacitor banks are adjusted differently according to the optimization technique employed.

Table 8 contains a summary of the results obtained by the different methods. In comparison with the OED, the PSO gives a reduction in the VD of 35.38%, while the APSO gives 44.61% reduction, the FPSO gives 55.07% reduction, and finally the FAPSO gives best reduction of 66.46%.

Moreover, there is a reduction in the real power loss of 3.99% using PSO, while a reduction of 5.01% is obtained using APSO, the FPSO gives a reduction of 5.97% and the reduction using the FAPSO reaches the 6.37%. The time elapsed for OED is 0.2383 second which is the smallest for all optimization technique because all control variable values are constant, thus has only a single solution, while for the PSO technique was 13.3194 second, the APSO takes 12.5933 second, also the FPSO elapse 14.0566 seconds and FAPSO time elapsed is 14.1275 seconds, which is the largest one. This small incremental in time for FAPSO technique can be tolerated when considering the significant improvement in voltage deviation and real power loss reduction. The comparison

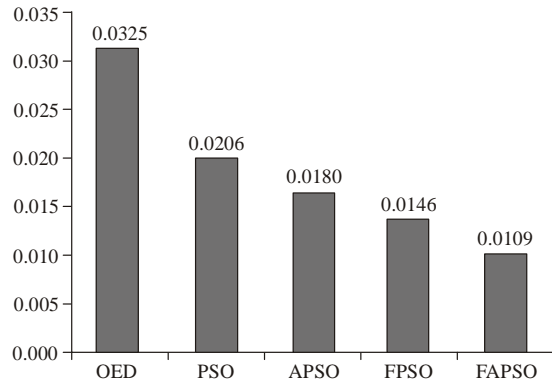

Fig. 15: Voltage deviation

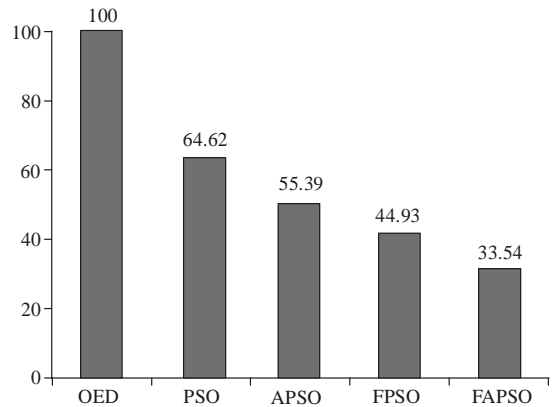

Fig. 16: Percent of voltage deviation

shows clearly the superiority of the proposed technique FAPSO over the traditional optimal economic dispatch method.

Figure 15 represents the magnitude of voltage deviations after obtaining the final solutions for the five voltage control strategies. For all cases, the magnitudes of the voltage deviation lie within a tolerable range. It is noted that the magnitude of this deviation is largest for the OED and is smallest for the FAPSO. This shows that one of the main objectives has been satisfied. Figure 16 presents the percentage of voltage deviation in the various techniques when taking the OED as a reference case.

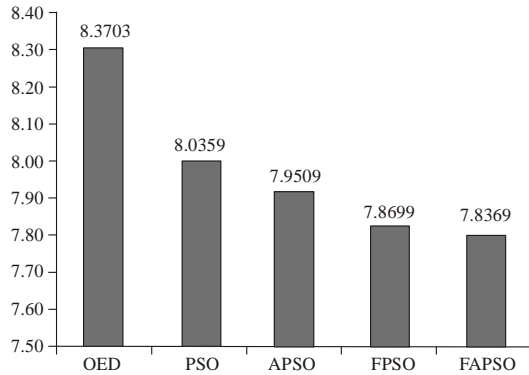

Fig. 17: Real power loss

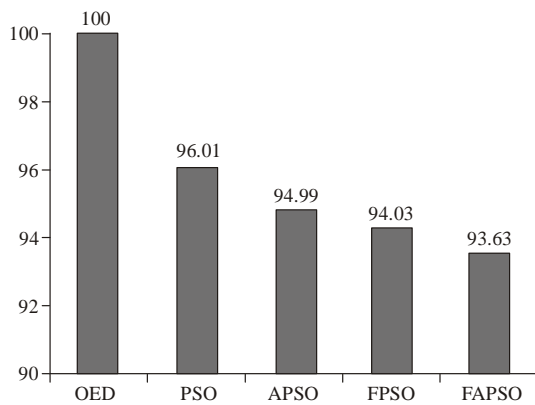

Fig. 18: Percent real power loss

Figure 17 presents the real power loss for all voltage control strategies. It shows that the real power loss for OED is the largest at 8.3703 MW, while it is the smallest for FAPSO 7.8369, and this also satisfies the second objective. Figure 18 presents the percentage of the real power loss of the various techniques when taking the OED as a reference case. It should be mentioned that the simulation and calculations are implemented using the Matlab programming language and executed on a PC with a Pentium IV, Intel Core 2 Due 2.26 G CPU.

CONCLUSION

Various optimization methods have been employed to obtain a multi-objective solution to the IEEE 30-bus power system model. The objectives set for the study are the voltage control, the voltage deviation, and the real power loss. The Optimal Economic Dispatch and various Particle Swarm Optimization methods are applied to the system model. For all particle swarm techniques, the swarm size is taken as 50 and the number of iterations is

set at 20, the inertia weight is linearly changed from 0.95 to 0.7 according to a linearly decreased equation while the learning factors are modified using fuzzy logic. All techniques are employed taking advantage of a variety of control tools such as transformer tap setting, static VAR compensations and voltage-control buses in order to maintain an acceptable voltage profile while keeping the voltage deviation and the real power loss as low as possible.

All optimization methods have provided valid solutions to the problem addressed as far as the voltage magnitudes at the system buses and the range set for the control variables are concerned. It has been shown that all particle swarm techniques achieve better results than the optimal economic dispatch in regard to the voltage deviation and the real power loss. However, the proposed fuzzy adaptive particle swarm technique introduced in this study accomplishes the best results and supersedes the various particle swarm optimization methods employed in this study.

ACKNOWLEDGMENT

The authors wish to thank Dr. Basil Hamed and Dr. Mahir Sabra for their valuable remarks and comments during the conduction of this research. Special thanks go to the working staff at the Projects and Research Center (PRC) of the Faculty of Engineering at the Islamic University of Gaza for providing all facilities and adequate environment to undertake this study.

REFERENCES

- Al-Rashidi, M.R. and M.E. El-Hawary, 2009. A survey of particle swarm optimization applications in electric power systems. *IEEE Tran. Evol. Computat.*, 13(4): 913-918.
- Cui-Ru, W., Y. He-Jin, H. Zhi-Qiang, Z. Jiang-Wei and S. Chen-Jun, 2005. A modified particle swarm optimization algorithm and its application in optimal power flow problem. *4th International Conference on Machine Learning and Cybernetics, Guangzhou, August*, pp: 2885-2889.
- Gray, P., W. Hart, L. Painton, C. Phillips, M. Trahan and J. Wagner, 1997. *A Survey of Global Optimization Methods*, Sandia National Laboratories. Retrieved from: <http://www.cs.sandia.gov/opt/survey>, (Accessed on: 2 February, 2010).
- Hadi, S., 2002. *Power System Analysis*, 2nd Edn., McGraw-Hill, Inc., ISBN: 0072848693.

- Husam, S., 2010. Voltage Control Based on Fuzzy Adaptive Particle Swarm Optimization. LAP Lambert Academic Publishing, ISBN: 978-3-8443-2181-4.
- John, Z. and W.R. Joseph, 1954. Electric Power Transmission, The Power System in Steady State. The Ronald Press Company, New York.
- Li-Xin, W., 1997. Course In Fuzzy Systems and Control, A. 1st Edn., Prentice Hall, New Jersey, USA. ISBN13: 9780135408827
- Mamdani, E.H., 1974. Application of fuzzy algorithms for the control of a dynamic plant. Proc. IEEE, 121: 1585-1588.
- Prabha, K., 1994. Power System Stability and Control. McGraw-Hill, Inc., ISBN: 007035958X.
- Rardin, R., 1998. Optimization in Operations Research. Prentice Hall, New Jersey, USA, ISBN: 0023984155.
- Russell, E. and James Kennedy (1995), Particle swarm optimization. Proceeding IEEE International Conference on Neural Networks (Perth, Australia), IEEE Service Center, Piscataway, NJ, IV:1942-1948.
- Thierry, V.C. and V. Costas, 2008. Voltage Stability of Electric Power Systems. Springer, ISBN: 0792381394.
- Timothy, J.R., 1997. Fuzzy Logic with Engineering Applications. McGraw-Hill, New York, ISBN: 0070539170.
- Van den Bergh, F., 2002. An Analysis of Particle Swarm Optimizers. Ph.D. Thesis, Department of Computer Science, University of Pretoria, South Africa.
- Venter, G. and J. Sobieszcanski-Sobieski, 2002. Particle Swarm Optimization. The 43rd AIAA/ASME/ASCE/AHA/ASC Structures, Structural Dynamics and Materials Conference, Denver, Colorado, USA.
- Wen, Z. and L. Yutian, 2008. Multi-objective reactive power and voltage control based on fuzzy optimization strategy and fuzzy adaptive particle swarm, electrical power and energy systems. Int. J. Elec. Power, 30(9): 525-532.
- Yoshida, H., K. Kawata, Y. Fukuyama, S. Takayama and Y. Nakanishi, 2000. A particle swarm optimization for reactive power and voltage control considering voltage security assessment. IEEE Trans. Power Syst., 15(4): 1232-1239.